

# Section 11

Caps & Dipsticks .....	1, 7-9
Filters/Breathers .....	11-18
Guage Kits .....	10-12
Hose/Clamps/Tool .....	18-26
Oil Coolers .....	23-24
Oil Line .....	18-22, 24, 26
Oil Tanks and Covers .....	1-7
Pressure Gauge .....	9-12
Stainless Steel Lines .....	18-22
Temperature Gauge .....	8-12

# Oil Tanks



## FL/FX Chrome Oil Tank

An exact reproduction of the original oil tanks for all FX and FL 4 speeds 1982-86. Note: 1982-86 use #28921 battery carrier.

PCP	Description
77955	Chrome oil tank BT 1982-86 (no filter cavity) (62504-82)
3296	Chrome oil tank cap assembly (62610-52A)
77005	Chrome oil tank plug
939	Chrome 5" oil tank temperature dipstick



## Chrome Oil Tank Cap Assembly

Fits the original style oil tank on all 4-speed models to 1986 (except FXST).

3296	Cap (62610-52A)
------	-----------------



## FXST Oil Tank

Features center fill, 4 spigot type for 1986-99 FXST models, 3 quart.

77979	Raw
77985	Chrome



6252

6253

## Custom Polished Aluminum Oil Tank

Available in 5 quart tanks or a 5-quart tank with an integrated spin-on oil filter. Each tank comes complete with mounting hardware and oil line fittings. The 4-quart tank fits late style Sportsters, the 5-quart 74".

6252	5 quart tank, 8-7/8" long x 6-1/4" diameter
6253	5 quart tank with filter 8-7/8" long x 6-1/4" diameter
2501	Replacement filter element



## Rubber Mounting Studs

This is just the answer for custom builders. These studs are perfect for mounting gas and oil tanks.

1154	62563-65 (10 pack)
23006	Rubber w/internal spring (10 pack)

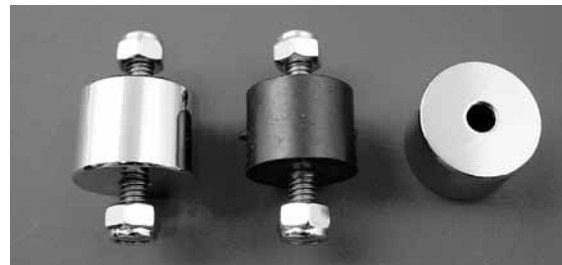

## Chrome Iso Mount Kit

Kit includes two 1/4 x 20 Iso mounts and two chrome billet covers.

44157



## Iso-Mount Chrome Cover

Covers black 1/4" Iso studs. Pair.

44069



## FXST Torpedo Round Oil Tank

Centre fill oil tank has a 5.5" diameter.

PCP	Finish
77987	Chrome
77988	Raw



## Steel Round Oil Tank

Fits FXST style Rigid and stock FXST frames. Utilizes stock front and rear FXST mount. Top brackets must be fabricated for installation for use with custom frames. (order bracket set separately)

77980	Chrome tank
77981	Raw tank
40102	Bracket kit only

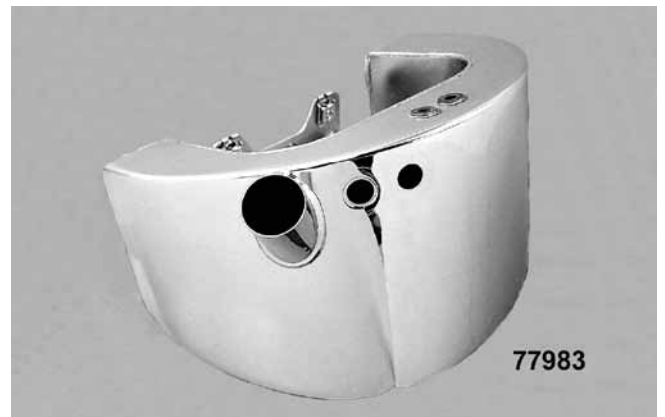

77983

## Chrome FXST Oil Tank

Is three quart with bottom exit hose fittings, battery box dimensions of 7-7/8" L x 4" W for 1984-99. Some years may require "T" fittings for oil drain. Order bracket kit separately.

PCP	Item
77986	Tank
10581	"T" fitting (62493-89)

## FXST 2000-on Chrome Oil Tank

Fits FXST models. Replaces 62498-00A

77982	USA
77983	PCP
59495	Chrome top mount
40106	Mount kit

# Oil Tanks



## FXST Oil Tanks

Chrome finish. Available for OEM or aftermarket frames.

**68302** 1991-99 All Softails® USA (62498-91)



## FXST 'Winged' Oil Tank 1984-99

Chrome oil tank with winged extension to fill in the gap between frame and oil tank.

**77963** Top fill cap

**77975** Side fill cap



## FXST Oil Tanks

Replaces 62498-89A. 4 Spigot type for 1984-99 Softail, FXST, FLST. Has welded seams. Steel tank with built-in battery tank.

**77950** Primer

**77951** Chrome (62498-89A)

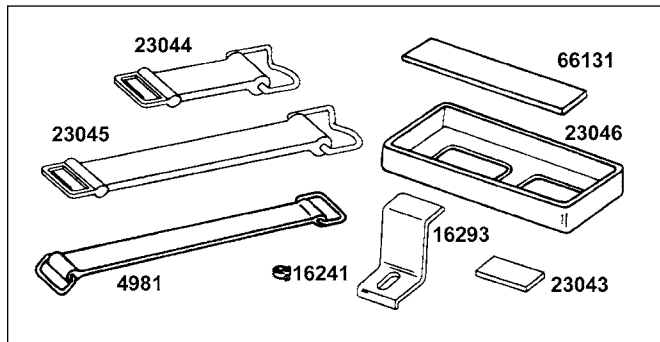

## FXST Battery Hardware

For 1984-99 Softail models.

PCP	Description
<b>4981</b>	Strap 1984-92 (66105-77)
<b>23043</b>	Clamp pad 1993-99 (66004-93)
<b>16293</b>	Clamp FXST 1993-99 (66185-93)
<b>23044</b>	Front strap 1993-99 (66109-93)
<b>23045</b>	Rear strap 1993-99 (66111-93)
<b>16241</b>	Vent clamp (10067) (10 pack)
<b>66130</b>	Tray insert 1986-96 (66210-85B)
<b>23046</b>	Tray insert 1997-99 (66210-97)
<b>23070</b>	Tray insert 2000-on (66210-00)
<b>66131</b>	Pad (66309-84, 66103-74A) (pair)



## FXST-FLST Oil Tank Mounting Kit

This kit includes all parts pictured for 1984-99 mounting of oil tank to Softail style frames. Replaces 62707-84, 62704-84.

**40102** Kit



## FXST Chrome Oil Tank Mount

Contour design fits stock and custom FXST frames 1986-99.

**40105** Kit

**27374** Rear mount only



## FXST Oil Tank w/Center Fill 1984-99

**77959**

# Oil Tanks



## T/L Chrome Sportster Oil Tank Cover

Easy to install cover mounts over your existing oil tank to give the appearance of a chromed oil tank. Mounting hardware is included with cover. Fits on 1994-03 XL models except those with a Deluxe Touring seat.

**64278** 62512-97



## FXST 3.5 Quart Round Oil Tanks

Tanks are 6.5" x 11.75" and mount to stock 1986-99 FXST frames.

Raw	Chrome	Fill
<b>77989</b>	<b>77998</b>	Center
<b>77990</b>	<b>77999</b>	Side



## Chrome Oil Tank For Late Sportster® Models

A great looking part that adds bright chrome to the right side of all Sportster® models from 1983-on. A copy of the OEM part, a one piece form fit cover is also available. Not for models with deluxe touring seat.

### PCP Description

<b>77948</b>	Black tank 1983-93 883-1200 (62475-83)
<b>77949</b>	As above, chromed
<b>77960</b>	Tank 1994-96 chromed (62475-94)
<b>77964</b>	Tank 1997-03 chromed (62475-97)
<b>45844</b>	Tank 2004-on black (62888-04)
<b>77007</b>	Dipstick 2 5/8" 1982-03 (62595-82A)
<b>45360</b>	Chrome cover 1983-93 attached by springs
<b>45361</b>	Chrome cover 1994-03 attached by clips
<b>59506</b>	Chrome cover 2004-on (66262-04)

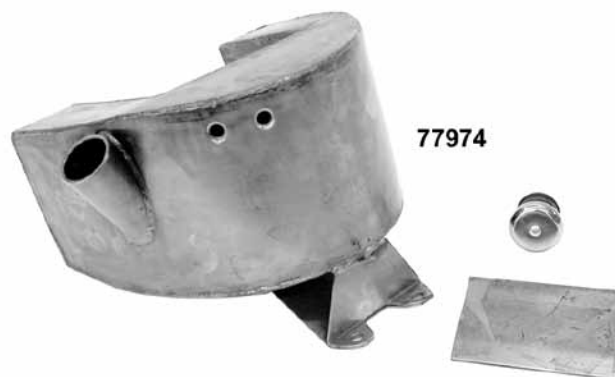

## Custom Oil Tanks (Unfinished)

**77974** XL Custom 3 quart oil tank for use with XLH battery

# Oil Tanks

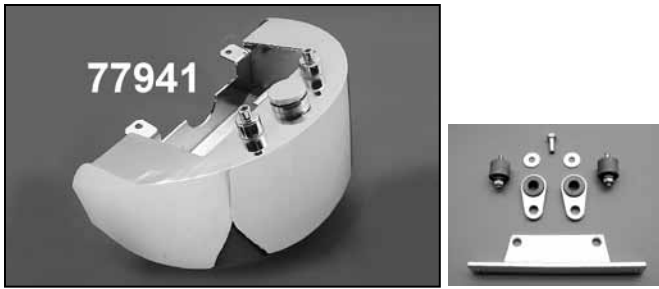

## Wrap Around Oil Tanks for 250 Frame

Features top mount ISO design. Bracket must be welded on. Some fitting required.

### PCP Description

77941 Chrome



## FXST Domed Round Oil Tank

Centre fill oil tank has a 5-1/2" diameter and 12-1/2" O.A.L.

### PCP Finish

77987 Chrome

77988 Raw

10615 Drain plug



## Chrome Oil Tanks

Fits FXST frames 1986-99.

PCP	Oil Fill	Shape	Finish
77942	Centre	Hex	Chrome
77943	Side	Hex	Chrome
77944	Centre	Custom	Raw
77945	Centre	Custom	Chrome



## 3.5QT Round Oil Tank for Twin Cam 2000-on

Tank measures 6.5" in diameter, 11.75" in length and fits Twin Cam 2000-on models. Requires removal of coil bracket and relocation of coil and custom oil lines.

77997 Chrome w/top fill

77994 Raw w/top fill

77995 Chrome w/side fill

77996 Raw w/side fill

40106 Mount kit



## Rubber Mounting Studs

Rubber mounts for oil tanks, battery trays, and other applications. Replaces 62563-65. Complete with mounting hardware.

72333 Set of 2.



## Battery Box Mounting Kit

Reproduction of original hardware mount battery box on 1965-84 FX, FL.

72331

# Oil Tanks



## Clean Change Oil Drain System

Provides mess free oil change on the difficult to change late model H.D.'s. Chrome plated steel, with chrome plated brass needle, includes drain hose and tie-wraps. FXR type-77023 includes left side mount bracket and bolts.

**77023** FXR-FXRS-FXRT 1986-91 (HD-B)

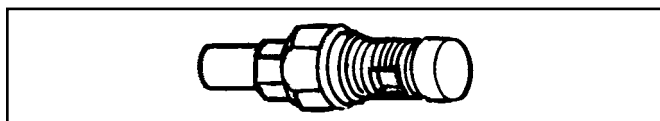

## Oil Drain Valve

These valves are made from '6061' alloy and is offered in a natural finish. Remove your stock drain plug (5/8-18TPI) and install the alloy unit (tighten 3/4"). Attach a 1/2" i.d. oil drain hose (from fitting to oil collection pan) and loosen fitting and oil begins to drain. After draining tighten fitting until it is seated and remove the drain hose. Oil draining is done with the 1/2" wrench surface.

**10524** Each



## Oversize Drain Plug & Tap Kit

Contains 1 chrome plated dome head plug with an oversize thread and one tap for rethreading the stripped out drain hole. Fits O.H.V. Big Twin Harley Engines 1965-on.

**1760** Kit

**1761** Oversize drain plug only



## Chrome Trans & Oil Drain Magnetic Plug

Fits 2000-on BT with 1/2-13 thread. Replaces 60328-98A.

**72295** Custom dome head

**72296** Stock style



## FXR Chrome Oil Tank 1982-94

For all FXR 1982-94 except 1986-on FXR Super Glides.

**77961** 62406-81



## Oil Temperature Gauge

Fits wrap around oil tanks.

**77010**

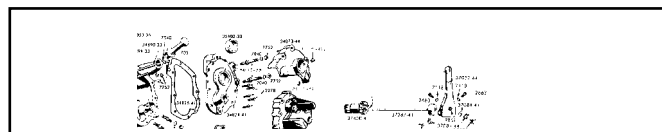

## Drain Plugs

B. Fits XL trans, motor, oil tank and BT 1937-86 trans. 1/2"-13

**5259** Chrome

**5260** Cad

C. Chrome plug with gasket for 1981-on BT with 1/2"-20.

**5258**

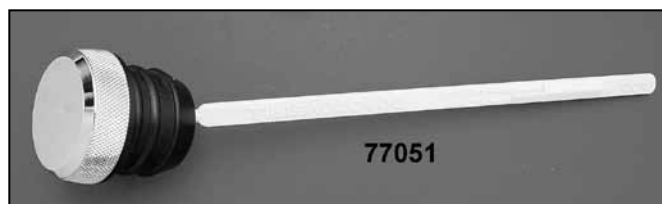

## Chrome Dipstick

**PCP** Application

**77050** 1991-on FXD (62681-92A)

**77051** 1993-98 FLT (62640-93)

# Oil Caps



## Chrome Maltese Oil Caps

Fits FXST and FXE tanks.

**77046** Dipstick 1979-03

**77049** Dipstick w/3" probe FXST, FLST 1984-99



## Oil Temperature Dipstick

LCD display with push button for 5 second readout. Red light shows extreme temperature.

**1984-on Evo BT and FXST**

**77025** 1984-99 (2-1/2" probe)

**77017** 2000-09 (2-3/4" probe)

**1984-03 XL**

**77026**



## XL Oil Dipsticks w/3" Probe 1982-03

**29210** Chrome (62734-96A)

**29211** Satin (62735-96)



## Oil Dipstick with Temperature Gauge

XL 1982-on. 50 to 350 degrees.

**77015** 1982-03 w/3" probe (62667-87TA)

**77022** 2004-on XL w/1-5/8" probe

**29032** T/L as above with Logo (63023-05)



## T/L Transmission Oil Dipstick

Hand-operated dipstick features an engraved logo and chrome finish. Easily installs on all 1987-99 Evolution 1340 models and 1999-06 Touring, 2000-06 Softail and 1999-05 Dyna Twin Cam models. Will not work with oil pump covers OEM# 66394-93 or 66088-96 or hydraulic clutch.

**64309** 37123-98A



## Oil Tank Cap & Dipsticks

Are rubber plug-in type with chrome cap to fit stock or custom tanks. Dipstick type replaces 62625-70 for use on FL, FX 1970-on, with level markings.

**77005** Chrome Plug

**77006** Dipstick w/5" probe (62644-84T)



## Oil Tank Dipstick

Stock style dipstick fits 1999-05 Dyna

**77009** 62857-99

# Oil Gauges



## “Revolution Cycle” Oil Pressure Adaptor for Evo Motors

This trick item is manufactured from 6061 T6 aluminium and is offered in 2 versions and 2 finishes. 1 hole adaptor is for a pressure gauge & 2 hole adaptors are for a pressure gauge and the stock sending unit. Easy to install. Use teflon tape on the threads and tighten to the nine o'clock position for the stock oil light gauge. Stock exhaust with cross-over tube may interfere.

### 2 Hole for Light Unit & Pressure Gauge

- 27100** 2 hole version (silver anadize)
- 27101** 2 hole version (black finish)

### 1 Hole for Pressure Gauge Only

- 27102** 1 hole version (silver anadize)
- 27103** 1 hole version (black anadize)



## Oil Pressure Gauge

Chrome or stainless steel case and rim house available either liquid or air filled 60 or 100 lb. with 1-1/2" face, 1/8" NPT male rear fitting. Black face gauges have a 1.600 body and 1.960 rim. Stainless gauges have a 1.580 body and 1.735 rim.

### PCP Pounds Type

- 77014** 0-60 Liquid, black with chrome body
- 77013** 0-100 Air filled



## 1-1/2" Liquid Filled Oil Pressure Gauges

Weather resistant sealed lens, stainless steel case, chrome rim and extra heavy mechanism. Liquid filled face eliminates needle bounce giving a constant reading. All gauges have 1/8" NPT male rear fitting.

- | PCP          | Pounds | Face   |
|--------------|--------|--------|
| <b>77004</b> | 0-30   | Black  |
| <b>77018</b> | 0-60   | White  |
| <b>77054</b> | 0-60   | White  |
| <b>77055</b> | 0-60   | Silver |
| <b>77001</b> | 0-60   | Blue   |
| <b>77056</b> | 0-60   | Black  |
| <b>77019</b> | 0-100  | White  |
| <b>77012</b> | 0-100  | Black  |



## Accel Liquid Filled Oil Pressure Gauges

1.5" Stainless steel housing hold a pure glass lens that will not fade, distort or melt. Solid brass internals are set in vibration dampening glycerin. 1/8" NPT rear mounting gauges are available in on 2 PSI ranges.

- 77016** 0-60 PSI
- 77024** 0-100 PSI

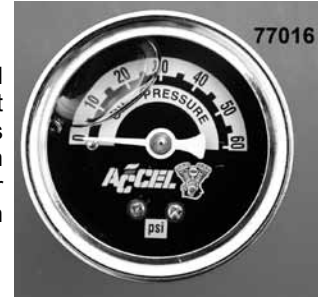

## Oil Plug Temperature Gauge for Stock

This highly accurate gauge quickly responds to oil temperature up to 350°F. Fits most stock and custom tanks for most models with plug-in oil cap. Measurements provided are for probe length.

- 939** 5" For many models 1980-86 FLT (62635-79T)
- 48101** 5" For 1987-92 FLT and 1984-94 FXR/T (62666-87T)
- 48102** 2-5/8" For 1984-99 Softail (62668-87T)
- 48104** 2-7/8" For 2000-on Softail (except FXCW/C, FXSTSSE3) (62896-00)
- 29206** 3-3/4" Topline as above
- 14597** O-ring for 2000-on FXST dipstick (10 pk)

# Gauges

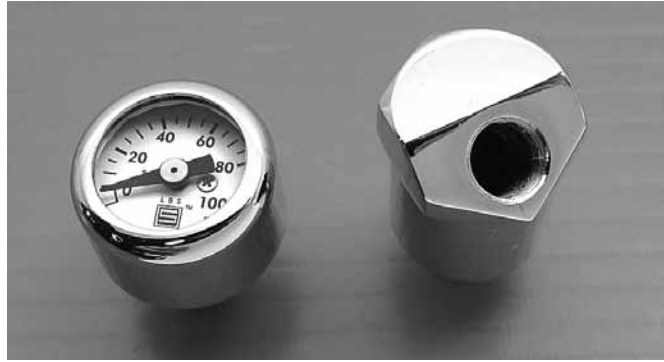

## Mini Oil Gauge Kit 1984-99

Includes 1" mini gauge and chrome fitting.

**PCP Description**

**77029** Kit for 1984-99 Evo BT

**77020** 1/8" NPT gauge only



## Chrome Oil Pressure Cover BT 1984-99

Fits BT 1984-99 models with sending units.

**73524**

## Evolution Oil Gauge

Unique rocker box mounted gauge can be read while sitting on cycle. Complete kits include a liquid filled gauge, chrome steel line and hardware for installation. The kit is also available with lower fitting allowing stock oil pressure sender unit to be retained in conjunction with oil pressure gauge.

Also replaces the sender unit.

**PCP 1984-99 1340 Big Twins**

**77052** 1" Mini kit (no oil pressure sender)

**77053** 1½" Gauge kit (no oil pressure sender)

**77035** 60# oil pressure gauge kit

**59528** Line and bracket kit (no gauge)

**59529** Complete kit w/sender adaptor

**PCP XL Evo 1985-90 883-1200**

**77104** Liquid 60# oil pressure gauge kit with black face, chrome rim and stainless steel case



## Sifton Rocker Box Oil Pressure Gauge Kit

Feature 0-60lb liquid filled pressure gauge, case fitting which allows retention of oil pressure switch for indicator light with chrome bracket and screw to mount to head. Kit includes stainless steel line.

**PCP Application**

**77041** 1984-99 Evo

**77042** 2000-on TC88

**77043** 1991-on XL



# Oil Filters



## Original-Style Accessory Oil Filter System

Exact chrome replacement for 63800-48 on BT 1948-64 and can use the OEM bracket and stock steel oil line and fitting sets. Filter can be fitted to 1965-84 FL and FX models by use of bracket #2682 or on FXST 1984-on with bracket #3321. Oil lines must be fabricated for these applications. Order brackets, lines and fittings separately. Features slip on hose fittings which can be substituted with screw in fittings to accept metal lines.

### PCP Fits

- 3293** Chrome oil filter assembly includes complete gasket kit and filter element (63800-48 and 63800-58)  
**25606** Complete gasket kit for oil filter assembly  
**3290** Filter element (63840-48A) (each)



## Chrome Oil Filter Mounting Brackets

Each of these all-chromed, steel brackets mounts an accessory oil filter. They were designed for use in conjunction with oil filter kit 3293. Available for both rigid and swingarm original equipment 4-speed frames as well as Softail® models from 1984 to present.

### PCP Fits

- 2682** 1965-1986 4-speed Big Twins except FXR & Softails (oil lines must be made)  
**3321** All Softail® models from 1984-99



## Chrome Oil Gauge Cover

Machined alloy cover has square hole in the bottom.  
**44025**



## Magnetek Chrome Oil Filters

Features a magnetic ring in centre tower to trap particles less than 10 microns which could have escaped through the filter wall. Available in stock style or with built in hex nut.

### Hex Stock Application

- | Hex          | Stock        | Application                          |
|--------------|--------------|--------------------------------------|
| -            | <b>77230</b> | 1982-86 FX (63782-80)                |
| <b>77244</b> | <b>77231</b> | 1980-on 5 speed FXST, FLT (63796-77) |
| <b>77245</b> | <b>77232</b> | 1991-on Dyna (63813-90)              |
| <b>77246</b> | <b>77242</b> | 2002-on VRSC (63793-01)              |
| <b>77247</b> | <b>77243</b> | 1999-on BT TC-88 (63798-99)          |



## TC Oil Pressure Gauge Kit-USA

Includes oil filled gauge, chrome mounting bracket and mounting hardware. Fits Dyna 1999-05, FLHT, FLHR 1999-on and Softail 2000-on. Will not fit with billet rocker covers.  
**29423** 75133-99

# Oil Filters



## Rocker Box Mounted Oil Gauge Kit BT 1984-99

Kit includes a complete liquid filled gauge, chrome steel line and hardware for installation. Kit is available with lower fitting allowing stock oil pressure sender unit to be retained in conjunction with oil pressure gauge.

- 77035 Without oil pressure sender
- 77036 With oil pressure sender



## Oil Filter Adaptors

- | PCP   | Application  |
|-------|--|
| 59105 | 1986-90 XL, 1982-99 FXR, 1992-99 FXD, 84-99 BT                                       |
| 59106 | 1999-on TC88, FXD, FXST; 1984-on Evo, FLT; 1998-on FLT, TC88 FLT, 1999-on TC88B FXST |
| 2500  | Chrome filter for above models listed  |
| 25290 | Rubber base seal   |
| 25291 | Gasket for PCP# 59106  |



## Crankcase Breather Assembly

Mount your breather in plain view instead of hiding it behind your engine or transmission case. Comes complete with a one-piece filter molded to a lightweight chrome end cap, a chrome zinc die-cast mounting base with 5/16" inlet and a hose clamp. The hose clamp holds the filter to the base when the vent hose is installed.

- 77101 Complete assembly
- 4634 Replacement filter ONLY as shown (no chrome)  
2" diameter x 1/2" height



## T/L Twin Cam 88 Oil Filters (USA)

Available in chrome or black, this filter traps virtually all particles over 10 microns in size. Fits Twin Cam 88 and Evolution engines 1999-on but can also be retrofitted to most earlier models.

- 62350 Black (63731-99)
- 62351 Chrome (63798-99A)
- 62353 As above (box of 12)



## T/L Spin-On Oil Filters

USA made filters have a cured resin paper filter with a metal end cap. Thermal setting adhesive provides a positive seal that prevents foreign particles from circulating through the oil.

- 62347 Chrome, short. L1982-84 FLH-80 Classic; 1982-86 FXWG, FXSB, FXEF (63782-80)
- 62348 Chrome, extra long. 1991-98 Dyna (63813-90)
- 62349 Chrome, long. 1980-98 FLT, FLHT, FLHR; 1982-94 FXR, 1984-98 Softail; 1984-95 FXRP, FLHTP; L1984-on XL (63796-77A)
- 62346 VRSC 2002-on (63793-01K)



## T/L Oil Pressure Gauge 1997-on

Comes with bulb and socket to fit FLHTC/Ultra/Injected models.

- 29430 1999-on (75032-99B)

# Oil Filters



**FXST Offset Filter Adapter**  
59648



## Billet Oil Filter Stock Cannister

Includes washable inner stainless filter to replace stock spin-on units  
59649



## FXST Style Oil Filter Kit

Frame mount kit features late 1984 styling of the FXST unit. Bolts directly behind shifter plate on all FX-FL-FLT, 1970 & up. Can be used as easy access auxiliary unit in addition to filter in tank. Inlet and return lines are stamped on bracket. Includes chrome filter and 6' of rubber hose.

- 4847** Kit with hose
- 2500** Chrome filter
- 3841** Black filter



## Spin-On Oil Filters

Spin-on oil filters come complete to replace the stock filter unit with no adapting. Available chrome or painted.

### FILTER APPLICATION CHART

PCP	Finish	Application
<b>2501</b>	Chrome	1982-86 BT 4-speed, all accessory type filter kits (63782-80)
<b>3839</b>	Black	Same as above (63810-80)
<b>3841</b>	Black	1985-on All XL, 1980-98 all FLT, 1982-94 all FXR, FXST 1984-98 (63806-80T)
<b>2500</b>	Chrome	Same as above (63796-77A)
<b>77220</b>	Black	Taller filter for Dyna 1991-98 (63812-90)
<b>77221</b>	Chrome	Taller filter for Dyna 1991-98 (63813-90)
<b>77222</b>	Chrome	BT TC-88 1999-on (63798-99)
<b>77223</b>	Black	As above (63731-99)
<b>77212</b>	Black	VRSC 2002-on (63793-01K)
<b>77213</b>	Chrome	VRSC 2002-on (63793-01K)



## Hex Nut Spin-On Oil Filters

Available in chrome or black. Hex nut style allows for easy installation and removal. All PCP filters are a low restriction type filter. All K&N filters feature improved pressure relief valve, anti-drain back valve and heavy duty base plate with improved rolled seal.

PCP	K&N	Finish	Size	Application
<b>77233</b>	<b>77224</b>	Chrome	Short	1980-E84 (63782-80T)
<b>77235</b>	<b>77226</b>	Chrome	Tall	L84-on Ev (63796-77T)
<b>77234</b>	<b>77227</b>	Black	Tall	L84-on Ev (63805-80T)
<b>77237</b>	<b>77228</b>	Chrome	Tall	Dyna 91-98 (68313-90)
<b>77236</b>		Black	Tall	Dyna 91-98 (63812-90)
<b>77238</b>		Chrome	Short	TC 1999-on (63798-99)
<b>77239</b>		Black	Short	TC 1999-on (63731-99)
<b>77240</b>		Black		VRSC 2002-on
<b>77241</b>		Chrome		VRSC 2002-on

# Oil Filter



## Perf-Form Oil Filters

Top quality, made in USA spin on filters for models from 1980 to present.

The 2-1/2" filter features 24 square inches more pleated paper than comparable filters, and an anti drain back valve not found on most other filters. Fits BT 4-speed L1982-86

### PCP Description (HD-3)

**77202** Black (each) (63810-80)

**77302** Same as above chrome (each)

The 3-1/2" filter is one inch longer than stock to increase the oil capacity of the system. Fits all 5-speed models (Dyna 1987-89 and FXST 1987-98), L1984-on Sportsters, Softails 1984-86 and most Harley Davidson accessory oil filter kits.

### PCP Description (HD-2)

**77204** Black (each) (63805-80A, 63806-83)

**77304** Chrome (each)

5-1/2" Tall version fits Dyna Glides 1991-98

### PCP Description (HD-4)

**77206** Black (each) (63812-90)

**77306** Chrome (each) (63813-90)

Twin Cam and fuel injected models, 3-1/2" long. 1999-on

### PCP Description (HD-2C1)

**77310** Chrome (each) all TC 1999-on



## Perf-form Spin-on Oil Filter Cooler to 1999

Filter cooler mounts directly to any 3/4" x 16" thread spin-on filter mount. Cooler includes finned aluminum canister housing, stainless steel nut plate, port nut, seals, 3 disposable replacement filter cartridges, and a socket filter wrench for mounting and cartridge replacement.

### PCP Description

**77028** Black filter cooler for all models including fuel injected models (HD-CXIB)

**77216** Replacement filter cartridge for cooler listed above

## Oil Filter Wrench

Fits all spin-on filters. Has 3/8" drive. All models including TC.

**59252**



## Combination Oil Filter Wrench

Includes drain plug hex at opposite end.

**26168**

# Oil Filter Kit



## Front Mount Filter

This kit incorporates filter and regulator mount for Big Twins 1975-99 and FXST-FLST 1986-99. Includes chrome filter, hose fittings, and chrome billet base.

- 77442** Complete kit
- 2501** Chrome filter (imported)
- 77302** Chrome filter (Perform)



## Oil Cooler-Filter Kit

Includes chrome canister filter FLT type, finned aluminum mounting flange, with hose and clamps. Mounts to most Sportster XLH or FX-FL's.

- 77440** Filter kit
- 2500** Chrome filter



## Pura-Flow Oil Filter Kits

Full flow automotive style spin-on oil filter kits. Kits include a chromed heavy-gauge steel bracket, chrome oil filter, and all required hoses and clamps.

- 4685** Fits all 1936-99 Big Twin
- 2500** Chrome filter for above kits

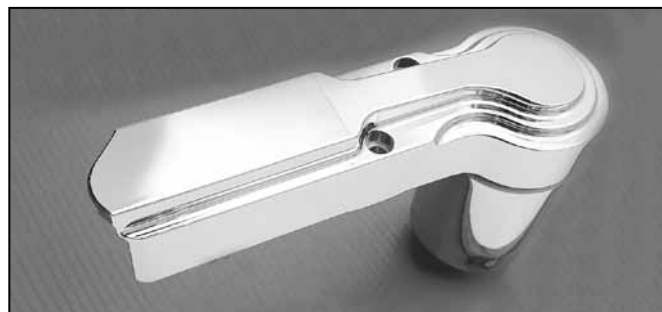

## Pura-Flo Universal Clamp On Oil Filter

Includes filter and hose.

**59444**

## Radii Contour Oil Filter Bracket

Long design covers oil lines and connections. Fits 1992-99 Evo models and S&S cases and motors with the mount holes. Includes filter.

**77462**

# Oil Filter Kit



77444



77441

## Chrome Oil Filter Housing

Fits Big Twin models 1991-on when the filter bolts to the right front side of the engine.

- 77441** Chrome housing only 1992-99 (26381-92)
- 77221** Chrome filter, FXDG 1991-98 (63813-90)
- 2500** Chrome filter (63796-77A)
- 10501** Male nut fitting BT 1992-on (63530-92)

## Chrome Oil Filter Housing BT 1992-99

Fits BT 1992-99 models when the filter bolts to the right side of the engine.

- | PCP          | Description                              |
|--------------|--|
| <b>77444</b> | Chrome housing kit w/lines               |
| <b>77030</b> | Return tube (33519-92A)                  |
| <b>77031</b> | Feed tube (33520-92)                     |
| <b>10594</b> | Tube connector (63523-92A)               |
| <b>14106</b> | Seal (63528-92)                          |
| <b>79457</b> | Seal, James (63528-92) (5 pack)          |
| <b>10501</b> | Nut (63530-92)                           |
| <b>77221</b> | Chrome filter FXDG 1992-98, Dyna 1991-98 |
| <b>2500</b>  | Chrome filter FXST 1982-on               |
| <b>9821</b>  | Allen mount kit                          |
| <b>9822</b>  | Acorn mount kit                          |
| <b>10051</b> | Fitting (26352-95A)                      |



45043



45044

## Chrome Oil Filter Housing Covers

These stamped steel covers were designed to fit over the OEM oil filter housing on your late-model Big Twin. They "dress up" the right side of your ride and install in minutes. The later version is held in place with silicone (included in the kit) and the earlier version is pinched between the frame and the filter housing when the mounting bolt is tightened.

- | PCP          | Description                                       |
|--------------|---|
| <b>45043</b> | 1986 Heritage Softail, All Softail models 1989-91 |
| <b>45044</b> | Big Twin models 1992-99                           |

## Oil Filter Mounting Bracket-USA

Natural finish mounting bracket for oil filter on FLT, FXR, FXST 1985-90.

**27157** 26350-85A



## Oil Filter Customizer Dress Up Kit

Includes chrome covers for oil filter housing, tappet blocks and oil pump on BT 1340 models 1992-99.

**45426**



## Chrome Oil Filler Spout

Fits 1993-06 FLT models.

**45349**

## TC-88 Chrome Oil Hose Cover

Fits FLHT 1999-06 and includes chrome mounting hardware.

**45348**



# Oil Filters



## Contour Oil Filter Bracket

Bracket is 1/2" thick with external fittings for 1992-99 Evo engines.  
**59170**



## Chrome Housing and Filter Kit TC "A" 1999-on

Kit fits Twin Cam 88 "A" models 1999-on and replaces 26321-99A.

**77034** Kit  
**9939** Allen mounting kit



## Chrome Billet Crankcase Breather

Includes 1/8" NPT fittings.  
**77106**



## Colony Mount Kit

**9938** Acorn filter adapter Dyna 1999-on  
**9949** Oil hose cover Dyna, FLT 1999-on



## Sifton Chrome Oil Line Adaptors

Adaptors allow 3/8" rubber or braided oil lines to be connected to TC88B motors. The inside of these adaptors are designed to function as a compression fitting. 3 piece set. Hex size is 1" with 3/4 threads into case.

**59055** 3/4" Thread TC88  
**73591** 1/8" NPT Thread Early  
**73592** 1/4" NPT Thread TC88

# S.S. Oil Lines



## Engine Breather Oil Collector

Designed to collect the oil mist from breather hose which eliminates engine oil from collecting in air cleaner. Available in polished or chrome plated finish. Features an internal oil baffle that allows the oil and air to separate more efficiently promoting unrestricted breathing. On top is a high flow K&N air filter that can easily be cleaned. A 90 degree barbed fitting fits breather hoses perfectly. On the bottom is a drain plug to allow drainage on a regular basis. Measures 5-3/8" x 1-1/2" and includes chrome mounting clamp.

- 77438 Chrome
- 77439 Polished

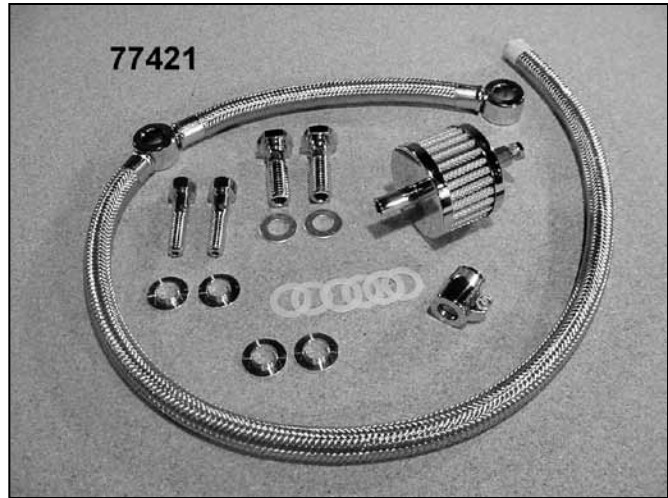

## Sifton Braided Hose Crankcase Breather Kit

Kit features a 3/8" I.D. braided stainless steel hose, breather filter with mounting stud, and hardware. Air cleaner and carb support bracket must be purchased separately. Fits 1993-2001 BT custom applications only.

- 77421 Complete kit including hardware
- 73500 Mounting hardware only



## Doherty Power Vent Twin Kits

Bolts directly to cylinder head breather outlets. Increases horsepower, improves throttle response and stops oil leaks by reducing pressure. Fits all 1992-99 model and includes hardware.

- PCP Application
- 77447 1992-99 Evo BT



## Chrome SS Oil Line Kit

Fits TC88 for custom applications. Includes 3 compression fittings and 3 seal ends. Hose must be cut for installation.



## Billet Oil Star Line Holder (each)

Polished billet with tie wraps. Takes up to 3 oil lines and keeps them in one bundle. For 3/8" oil lines and sold each.

71005

# S.S. Oil Lines

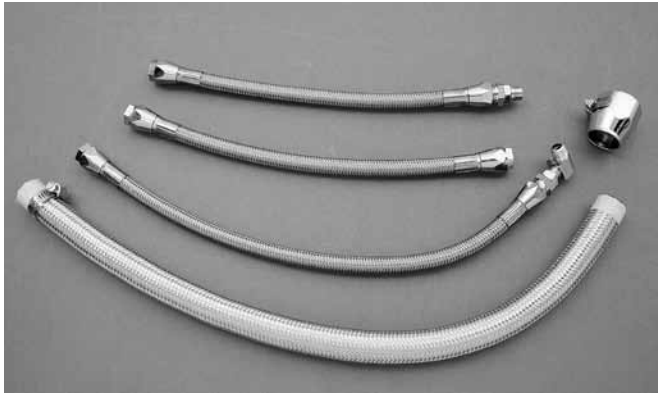

## Sifton Braided Oil Line Kit Softails 1992-99

Kit fits Softail models 1992-99 and includes stainless lines, seals and hardware as shown.

**77450**



## T/L Braided Oil Line Kit Softails 2000-06

Kits fit Softail models 2000-06 with TC88B engine and include stainless lines, chrome fittings, o-rings, and clips.

**77451** 63860-00



## Twin Cam Vent Line

Replaces stock rubber vent hose from motor to transmission and includes all necessary fittings.

**PCP Application**

**77455** Chrome vent line for 2002-06 Touring (33111-02)



## T/L Braided Oil Line Kit Softail 1992-99

Kit includes stainless lines, seals and hardware as shown.

**77453** 63705-97

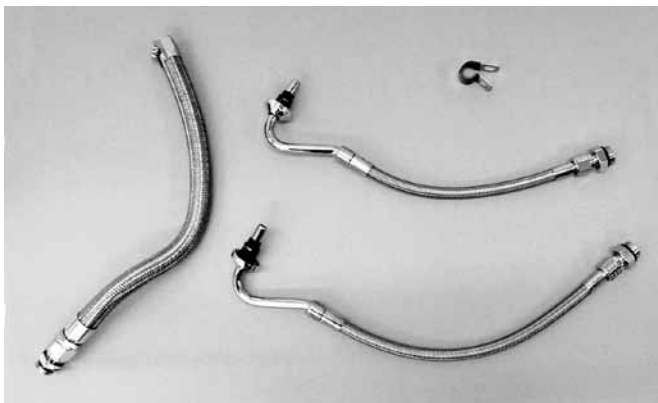

## Russell FXST Oil Line Kit 2000-on

Engineered specifically for the 2000-06 Softail, Supplied with aerospace style connectors at the motor combined with smooth radius blends and pre-formed feed line for the ultimate in fit with an easy installation. Professionally finished in high-luster chrome.

**77670**



## Oil Line Separators

Use these separators to neatly separate and route any 3/8" or 5/16" braided or rubber oil line. Available in polished or chrome alloy.

**27520** Polished 2 hole (each)

**27523** Chrome 2 hole (each)

**27534** Chrome 3 hole (each)



## Stainless Steel Oil Line Kit

Kit includes 10 feet of stainless line and 6 chrome clamps.

**77607**

# S.S. Oil Lines

## Stainless Braided Gas Line Kit

Includes braided, covered line and econo seal chrome end clamps.

**77425** 2 Ft. of 5/16" w/4 clamps

**77420** 16" piece of 1/4" w/ 2 clamps



## BT Oil Line Without Elbows

Fits most BT engines in all frames with a wrap around oil tank and tin primary covers. Fittings can be unscrewed from lines to make adaptations. Sold each.

**PCP Size**

**77604** 17"

**77605** 20"

**77606** 25"

## Oil Line Filter Kit

Includes filter and compression fittings for 3/8" SS hose.

**73590**



## T/L Chrome Oil Pressure Switch Cover

**64013\*** 1999-05 Dyna, 1999-03 FLHR and Electraglide Standard (66217-01)

\*Does not fit 1999-03 FLHT models with oil temperature gauge kit.

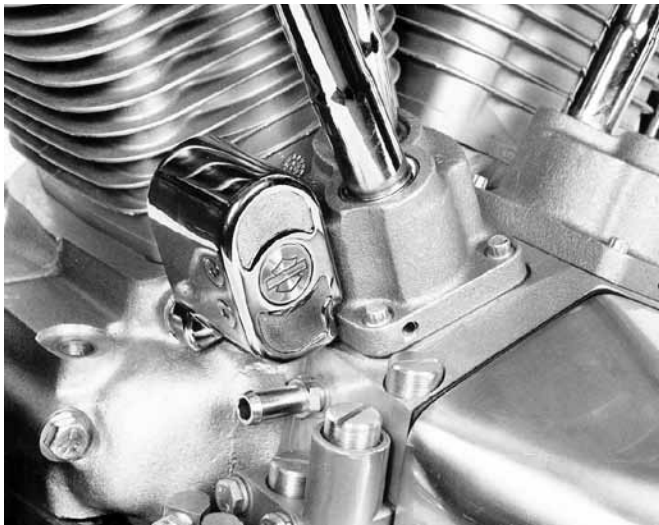

## Oil Pre-Filters

Pre-filters are constructed of machined alloy with a #40 mesh screen installed to trap large debris and a circular magnetic collar to collect ultra fine ferrous particles, before they reach the engine. The pre-filter unit can be installed in the following locations for 3/8" I.D. oil line:

- Supply line before engine, all models
- Primary scavenger return line on early FLH and FX
- Return line to oil tank on XLCH, FL, EL, UL and models without a factory filter
- External oil return on high pressure heads
- Any high pressure supply or return (use the pre-filter with the 1/8" NPT threaded body)

**PCP Description**

**17504** With 1/8" NPT threaded body

**17505** With 3/8" barbed end

## Pro Just Relief Cap

Without oiler for 1986-99 models.

**30401**



## Chrome Oil Pressure Switch Cover

Includes mounting hardware.

**64004** 1984-99 Evo (except Tour Glide, Electraglide and Road Glide (66232-97)

**64012** 1999-06 Electraglide Classic, Ultra and Road Glide, and 2004-06 Road King and Electraglide std (not for use with super premium oil cooler kit) (66218-01)

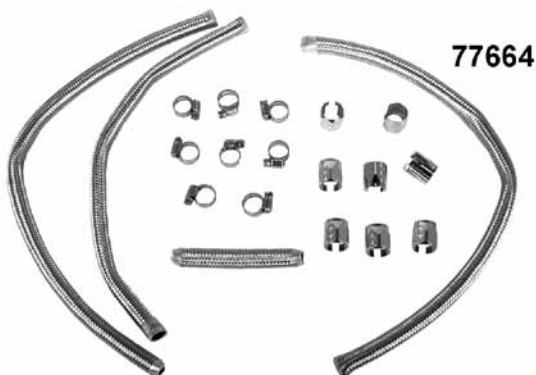

## Streetflex Pre-Cut Oil Line Kits

These Streetflex oil line kits are pre-cut to OEM lengths for easy installation and make use of tube seal hose ends to attach lines to stock oil fittings. Kits include stainless wire braided hoses, chrome plated hose ends and hose clamps.

PCP	Application	Lines Per Kit
77664	1982-96 FXR 5 speed (no cooler)	4
77668	1992-on FL/FX 5 Speed (no cooler)	7

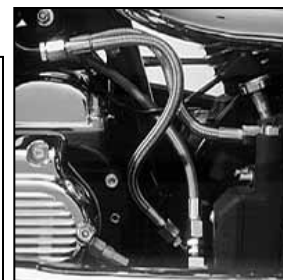

## Russell Pro System Oil Line Kits

These pre-assembled kits have been designed to replace stock factory hoses and to eliminate the use of hose clamps. For durability, performance and appearance, nothing beats Russell's stainless braided hose with chrome hose ends. The unique feature of these hose ends is a compression fit sealing system which ensures a positive seal.

PCP	Application	Lines Per Kit
77632	L1992-99 All Softail	4
77637	1994-02 All XL Sportster	3
77696	Oil line repair kit	12 rings

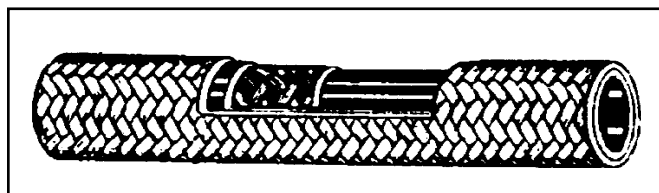

## Russell Streetflex Stainless Oil and Fuel Hose

Streetflex hose is engineered to replace stock OEM rubber hoses. Manufactured from superior quality CPE innerlined with a reinforced single wire outer braid for up to 250 P.S.I. Use econo-seal ends or hose clamps to attach to fittings.

49850	1/4"x3'
49851	5/16"x3'
49852	3/8"x3'
49853	1/4"x6'
49854	5/16"x6'
49855	3/8"x6'
49856	3/8" x 10'
49857	3/8" x 25'

**Warning: Not for use in brake systems.**



## Russell Universal Pro System Oil Lines

These pre-assembled oil lines are sold individually, perfect for custom bike applications. Constructed with stainless braided hose and crimped on chrome ends. The unique feature of these hose ends is the compression fit sealing system which ensures a positive seal. These lines are compatible with standard 3/8" oil pump and oil tank fittings.

PCP	Size
77641	8"
77642	9"
77643	10"
77644	11"
77645	12"
77646	13"
77647	14"
77648	15"
77649	16"
77650	17"
77651	18"
77652	20"
77653	22"
77654	24"
77655	26"



## Russell Chrome Tube Seal Hose Ends

Finish the look of your hose with these easy to install chromed, aircraft quality aluminum ends.

PCP	Size	ID	Qty
77697	#4.5	1/4"	6 pack
77698	#6	5/16"	6 pack
77699	#7	3/8"	6 pack



## TC Chrome Oil Hose Cover

Includes chrome hardware to fit Twin Cam models 1999-on.  
**64000** Dyna 1999-05 (not w/premium oil cooler) (37945-99)  
**64232** Touring models 1999-06 (37946-99) (not for models with premium oil cooler 62868-99 or oil temp gauge kit 75265-04 or 74513-04)

# Oil Lines



## Polished Stainless Steel Hose Lock (Each)

Use this compression fitting to replace conventional hose clamps. Offers a cleaner appearance and superior sealing performance. Sold each.

PCP	Size
73613	1/4"
73614	5/16"
73615	5/16" For S&S Super E carb fitting
73616	3/8"



## Compression Fitting and Hose Kit

Kit includes 6 compression fittings with 1/8" NPT threads and 10 ft of 3/8" stainless steel braided hose.

77458



## Combo Oil Cooler

Chrome unit features 2 billet clamps to fit 1" to 1.25" frame tubes and includes a 0-60lb built-in gauge.

77057



## Russell Oil Pressure Lines

Chromed braided stainless steel lines include a 1 piece fitting that makes installation a breeze. Use to replace the plastic line that runs from the oil pressure gauge to the motor.

PCP	Application
77659	1984-99 Evo BT
77660	1993-on XL
77661	1999-on Dyna, 2000-on Softail, 1999-on FLHT, FLHR



## Russell Pro-System Twin Cam Vent Lines

Chromed stainless steel lines are designed to replace the unsightly stock rubber hose that runs from the motor to the transmission. Kits include all necessary fittings.

PCP	Application
77656	1999-02 FXDL, FXDWG, 1999-01 FXDS Conv, 1999-02 Super Glide FXD and FXDX
77658	2002-06 FLHF/FLT/FLH



## Flex Chrome Hose Covering

Features heavy gauge mylar construction with chrome finish.

PCP	25' Length
77459	1/4"
77460	3/8"
77461	1/2"

# Oil Coolers

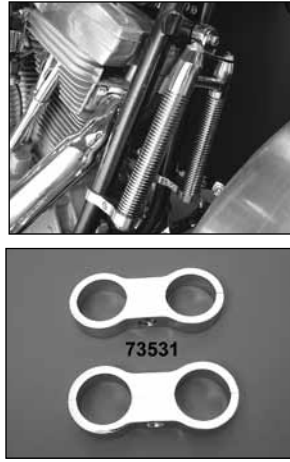

## Chrome Billet V-Cooler

Cooler measures 4-1/8" wide at top and each tube is 10.5" long and 1-1/8" in diameter. Cooler mounts to front frame tubes.

### PCP Application

<b>59209</b>	Cooler
<b>73530</b>	1-1/4" Frame clamp set
<b>73531</b>	1-1/8" Frame clamp set
<b>73676</b>	1" Frame clamp set



## Dual Cool Chrome Oil Cooler

Features reversible top bracket. Measures 9"H x 3-3/4"W with 1/8" cooling tubes.

**59181**



## Sifton Oil Cooler Kit

Includes Billet dual tube vertical oil filter with Billet mount clamps measuring 10" long and 4-1/8" at top diameter. Includes adapter for filter, SS braided lines and 4 chrome seal ends.

<b>59440</b>	FXST 2000-on
<b>59441</b>	FXD 2000-on
<b>59443</b>	FXST 1986-99
<b>59742</b>	FLT 1998-on
<b>59648</b>	Filter adapter only

## Billet Twin Oil Cooler Set

Features 2 independent cooler cannisters with billet clamp set for mounting to 1-1/8" front frame tubes.

**59493**



## Sportster Dual Cool Chrome Oil Cooler

Includes stainless steel hose and adapter fitting for engine to allow use of oil filter which is included on PCP# 59824 and #59825. 1971-on models may require bracket modification.

<b>PCP</b>	<b>Year</b>
<b>59824</b>	2004-on
<b>59825</b>	1979-03 (except 1200S & 1200C)

# Oil Lines

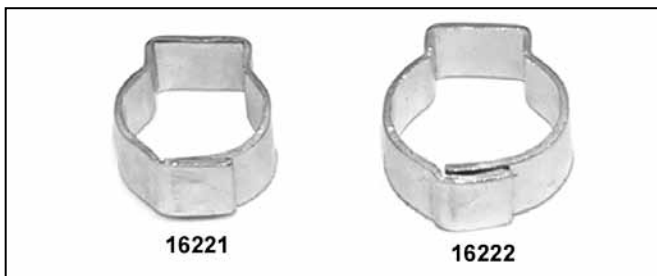

## Hose Clamps & Tool

OEM type clamp closing tool and clamps in bags of 10

PCP	Item	Use
5870	Tool	Crimping tool only (97087-65A)
16318		Plier and clamp assortment
16221	7/16-3/8	Oil hose (9996)
16222	1/2	Gasline (10014)
16223	19/32	Oil vent (10049)
16224	11/16	Oil filter XL 1979-on (10020A)
16299	19/32	Brake hose from reservoir FLT, FXR, FXST 1982-on (10038A)
16241	1/4	Battery vent hose (10067)
16220	11/32	Battery vent (9992A)
16228	11/16	Feed drain (10080)
16225	13/16	Oil drain hose (10086)
16317	1/2	Cam cover fitting oil line vent XL 1993-on (10117)
16298	13/16	Oil line XL 1995-on (10142)

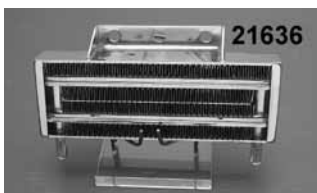

## XL Sifton Oil Cooler

Replica style cooler available in black or chrome. Order brackets separately.

PCP	Finish
21637	Black
21636	Chrome

### Brackets

17277	2004-on
17278	1982-03



## Top Quality Black Oil Line Hose for EVO

These oil lines are permanent formed for specific applications in precut lengths for stock replacement use only.

### Dyna

#### PCP

#### Description

62322	Crankcase to tank vent FXDB-S 1991-on (63534-90)
62323	Oil pan to pump feed FXDB-S 1991-on (63535-90)

### Softail

62334	Filter to tank Softail 1987-95 (63556-87)
62336	Tank vent Softail 1987-95 (63572-86)
62326	Tank to pump Softail 1992-96 (63515-92)
62333	Oil tank drain Softail 1991-95 (63553-91)
62332	Oil tank drain Softail 1990-on (63553-90)
62335	Filter to tank Softail 1992-95 (63556-92)

### FLT

62308	Oil pump to filter FLT, FXR 1987-92 (63558-85)
62300	3 Piece hose assembly FLT 1992-93 (62662-92)
62302	Filter to tank all FLT 1987-88 (62665-85)
62303	Filter to tank all FLT 1989-91 (62665-89)
62304	Oil pan to oil pump FLT 1993-95 (62683-93A)
62305	Trans case to filter FLT 1993-95 (62684-93)
62307	Trans case to crankcase FLT 1993-95 (63511-93)
62301	Oil tank to pump FLT 1987-91 (62663-84)
62306	Crankcase to oil tank FLT 1989-91 (63502-89)

### FXR

62309	Oil drain all 1986-on (63504-84)
62311	Oil tank to pump 1987-88 (63557-84)
62314	Oil tank to pump 1992-94 (63557-92)
62315	Crank case to tank vent 1987-88 (63559-84)
62316	Crank case to tank vent 1989 (63559-89)
62312	Crank case to tank vent 1990 (63559-90)
62319	Filter to tank all 1992-94 (63562-92)



## Chrome Oil Hose Cover

For 2002-06 FLT Touring models and must be used with 2002-on transmission interface cover. (Will not work with lifter block covers, or solenoid covers.)

61090	37961-02
-------	----------

# Fittings

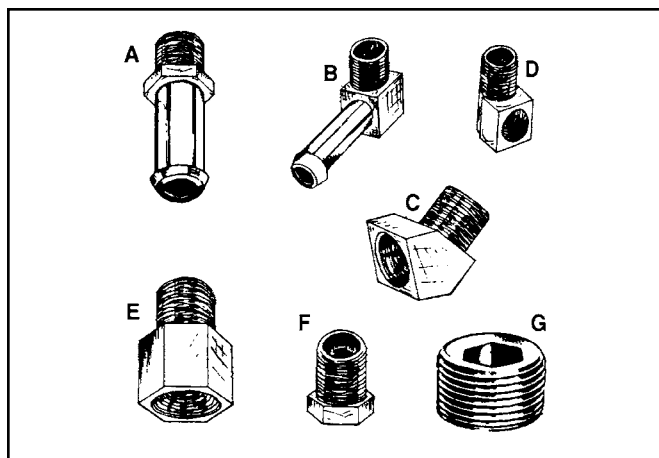

## Chrome Male Fittings

Measured in NPT thread and ID of gas/oil line. 5 packs.

(A) Straight	(B) 90 Degree	Size
10504	10502	1/8 x 5/16 Hose
10505	10517	1/8 x 1/4 Hose
10575	10518	1/8 x 3/8 Hose
10506	10519	1/4 x 5/16 Hose

## Chrome Male-Female Fittings

PCP	Type	Size
10507	(C) 45 degree street elbow	1/8 x 1/8 NPT
10520	(D) 90 degree	1/8 x 1/8 NPT
10508	(E) straight	1/8 x 1/8 NPT

## Male Plugs (5 pack)

PCP	Size
4698	(F) 1/8 NPT, chrome
10514	(F) 1/4 NPT, plain
10525	(G) 3/8 NPT hex socket plug, plain

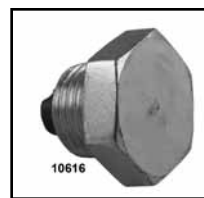

## Magnetic Drain Plugs

Prevents metal particles from circulating through engine and transmission cases, oil tanks, etc.

PCP	Size	Use
10610	3/8 x 24	BT Case plug 74 & 80 (not magnetic) (700)
10611	1/2 x 13	74 & XL Trans (707)
10615	1/4 x 18	NPT chain cover (718)
10612	5/8 x 18	Oil tank & time hole (720)
10616	5/8 x 18	FXR drain (722A)
10613	1/8 x 27	NPT 1987-89 BT primary trans FXST-FXR (734, 739A)
10614	1/8 x 27	As above with Hex
10619	1/8 x 27	NPT 1990-on BT trans (739A)
10618	1/2 x 20	74 & 80 Inner primary (60348-65A)

## Oil Drain Plug

For 1990-on Softails to seal oil hose.

10577	Fits 1990-00 (62725-90)
10579	Fits 2001-on (60328-98B)



## Oil Line Fitting

Features push in release button for installation 2000-on.

10570	(63783-00)
-------	------------



# Oil Line/Accessories



## Reinforced Black Fuel/Oil Line

Neoprene fuel and oil line for all Harley models. Available in shop supply 25-foot rolls, this top quality line is reinforced with high strength rayon. Neoprene outer cover resists oil and grease for years of trouble-free service.

- 3055** 1/4" x 25 feet
- 3056** 5/16" x 25 feet
- 3057** 3/8" x 25 feet



## Stainless Steel Braided Hose

To fit 3/8" lines.

- 6250** 6 foot piece
- 77430** 10 foot roll
- 77431** 25 foot roll



## Stainless Steel Braided Hose

To fit 1/4" lines.

- 77432** 10 foot roll

To fit 5/16 lines.

- 77433** 5 foot roll
- 77434** 10 foot roll
- 77435** 25 foot roll

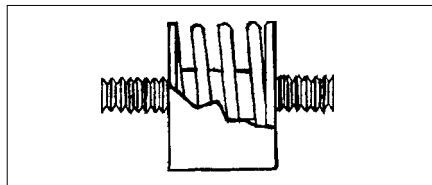

## Oil Tank Mounts

PCP	Description
<b>23006</b>	Heavy-duty (62563-65) (10 pk)
<b>1154</b>	Regular (62563-65) (10 pk)
<b>23069</b>	5/16" x 1/4" unc XL (62569-94)



## Oil Line Separators

Machined from aluminum, these oil line separators are a clean way to neatly separate and route any 3/8" or 5/16" stainless steel or rubber oil lines. Sold each.

- 27520** Polished
- 27521** Blue
- 27522** Black
- 27523** Chrome
- 27524** Red
- 27534** Chrome 3 hole



## Nylon Fuel Line

Sold in 25-foot rolls.

- 3048** 1/4" x 25 feet
- 3052** 5/16" x 25 feet
- 3054** 3/8" x 25 feet



## Econo-Seal Hose Ends

Reusable hose clamp fits all gas and oil lines to provide additional support and helps prevent cracking. The 5/16" ends fit 1/4" hose, 3/8" ends fit 5/16" and 3/8" hose.

- 875** 1/4-5/16" chrome (6 pack)
- 868** 5/16"-3/8" chrome (6 pack)



## Plain Finish Alloy Hose Clamp

Fits all 5/16" and 3/8" rubber oil-gas hose.

- 2968** Each



## FXST Oil Cooler Clamp Kit

Mounts standard Lockhart coolers. Includes 2 rubber-lined clamps.

- 27500** 62408-87



## Oil Line To Frame Clamps

Allows 5/8" O.D. oil lines to be clamped to frame tubes. Chrome, sold each.

- | PCP          | Size   |
|--------------|--------|
| <b>27527</b> | 1"     |
| <b>27528</b> | 1-1/8" |
| <b>27529</b> | 1-1/4" |



## Mini Hose Clamp

This quality clamp fits all 3/8" to 5/8" outside diameter hose.

- 3846** 3/8-5/8 Gas (10 pack)
- 3850** 1/2-3/4 Oil (10 pack)